

Spirit

WINNEBAGO



Why Spirit?

- Six versatile floorplans offer flexible sleeping spaces
- Optional package upgrades
- Large rear trunk
- Primera® fabric on sofa and dinette
- LED interior lights
- Available front cap upgrade
- Stylish vinyl ceiling
- Optional heated holding tanks



On the Cover: 31K Bronze Mist Deluxe Graphics with Available Front Cap

31K Infinity with Honey Cherry Cabinetry

Join the Motorhome Family

The Spirit® welcomes you to motorhome living with six floorplans ranging from 24 to 33 feet, and an array of optional feature packages that make it easy to find a coach to call home. Sleeping flexibility is paramount in a family-friendly Class C, and the Spirit delivers with an overhead bunk, multifunctional furniture, and even a

walkaround queen bed in some floorplans. In addition to standard features such as LED lighting and a large storage trunk, three available feature packages give you a wide range of options to upgrade both the comfort and style of your coach. It's time to heed the call of the Spirit, built to the legendary standards of Winnebago®.



2016 MotorHome
READERS' CHOICE
WINNER
Class C



31K Infinity with Honey Cherry Cabinetry

Few coaches provide the flexibility to select your features and styles like the Spirit. Start by picking from six floorplans, which range from 24 to 33 feet that include a traditional dinette (25B, 31D, 31G), U-shaped dinette (22R, 26A, 31K), and a sofa/bed (NA 22R, 26A) with soft Primera fabric that has a leather-like feel and performance. Add the available Premium Package (NA 22R, 25B) for a host of upgrades such as MCD solar/blackout roller shades, window treatment upgrades, and a larger HDTV (31K).



Pleated Night Shades



Cab Seats Swiveled with Booster Seats



31K U-Shaped Dinette



31K Available Front Overhead Bed



31K Available TrueComfort+ Sofa



31K U-Shaped Dinette as Bed



31K Available TrueComfort+ Sofa as Bed



Your feature flexibility continues in the galley with a variety of appliance options. The base package includes a microwave oven, 3-burner range top, and a 2-door refrigerator/freezer. Available upgrades include a microwave/convection oven (26A, 31D, 31K, 31G), 3-burner range with oven, and a large, 4-door refrigerator/freezer with icemaker (31K). The Premium Package adds style to the galley with available Corian® countertop and an undermount stainless steel sink (Premium Package requires Convenience Package).





31K Bedroom

Space-conscious travelers will appreciate the corner bed in the 22R and 25B. The larger floorplans make way for a private bedroom with a queen bed while each floorplan has the option to add an HDTV. Bunk beds in the 31G are perfect for kids or camping buddies and can be enhanced with an additional HDTV.



31K Vanity



31K HDTV



31K Shower



31K Wardrobe



31K Shirt Closet



31K Bathroom



Dash

Looking to add a little kick to your next trip? Add the Radio/Rearview Monitor System (included with the Convenience Package). It not only makes backing up safer, but incorporates a 6.2" touchscreen for the DVD player and stereo. It even connects to your phone or tablet and includes a handheld remote. SiriusXM® satellite radio is also available. Swivel cab seats are available in the 26A, 31D and 31K that turn the cab into an extension of the lounge.



Front Wraparound Curtain



Manual Mirror with Pivoting Arm

Take more with you in the large rear trunk storage compartment that is built into every floorplan. Outdoor living gets a big boost in the 31G when you add the exterior tailgate package. It includes an HDTV, DVD player, stereo, wash station, and a refrigerator. The patio awning can be upgraded to a powered model with LED lighting that keeps the party going into the night.



31K Available Powered Patio Awning with LED Lighting



Running Board



Exterior Service Center



31K Entrance Screen



Available Stainless Steel Wheel Liners



31K Exterior Rear Storage

TESTING Before rolling out of our factories, every coach undergoes an extensive 113-point inspection. Each coach also passes a high-pressure water test that simulates rain at a rate of 50-inches per hour to check for leaks. During the design process, our computer simulations, physical testing center, and rigorous test track ensure each model is built to last.



DETAILS At Winnebago, we treat the features you can't see with the same care as the ones you can. Look in the access panels of some of our competitors' coaches and you'll see loose insulation and wires haphazardly strewn about. Winnebago maintains a clean fit and finish throughout so your coach will last for the long haul.



BUILT IN-HOUSE We process and finish key aluminum parts. We rotocast our own plastic components. In fact, we manufacture most of our own parts so they are designed to fit the space, rather than fitting the space to an awkward off-the-shelf component size.



**SUPER
STRUCTURE**
BUILT TO LAST

W Visit BetterBuiltRVs.com to gain real insight into what goes into a Winnebago motorhome.

TAKE A TOUR We're proud of our processes, state-of-the-art facilities, and the people who make Winnebago number one. We invite you to visit our complex in Forest City, Iowa, for a firsthand look at the dedication and technology behind every motorhome we build.

Call (641) 585-6936 or (800) 643-4892 or visit us online at Winnebagolnd.com/company/visit for more information.



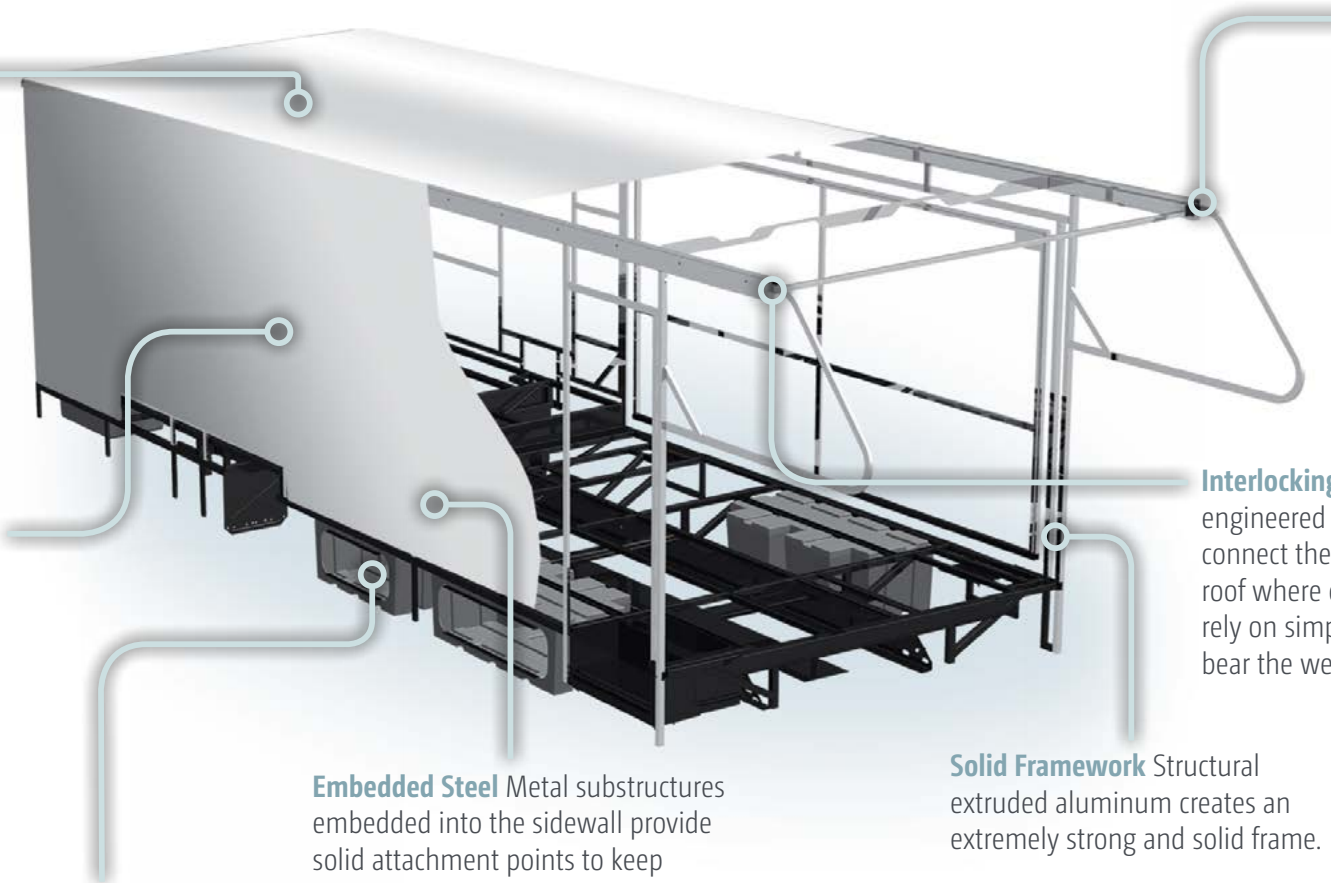

Fiberglass Roof

The one-piece fiberglass roof is backed by a 10-year limited parts-and-labor roof skin warranty.

Rubber Can't Cut It

Rubber roofs used by competitors can streak and degrade over time.

Thermo-Panel® Sidewalls

By layering fiberglass and high-density block foam insulation with welded aluminum support structures, we create some of the industry's strongest, most durable, and lightweight sidewalls.

E-Coating An electrodeposition coating helps protect critical steel components.

Embedded Steel Metal substructures embedded into the sidewall provide solid attachment points to keep cabinets and appliances mounted securely in place.

Laser-Cut Tubing

Precision laser cutters create precise joints in structural steel that are stronger and require less welding.



Interlocking Joints Specially engineered interlocking joints connect the floor, sidewalls, and roof where competitors often rely on simple screws to bear the weight.



Solid Framework Structural extruded aluminum creates an extremely strong and solid frame.

**SUPER
STRUCTURE**

BUILT TO LAST

Every coach—from our smallest Class C to our largest diesel-pusher model—is built to Winnebago's® legendary SuperStructure® construction design. It's a process developed and refined over more than 50 years of building some of the strongest, most durable coaches in the industry.

Choose from four collections and three wood finishes.

Legend



Primera



Feature Fabric



Bed Cover (22R, 25B)



Bedsread (NA 22R, 25B)



Laminate Countertop



Corian Galley Countertop
(Premium Package Upgrade)



Vinyl Flooring

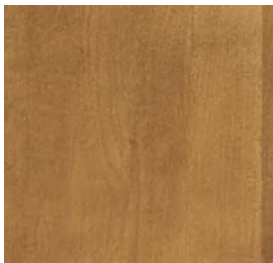

Coffee-Glazed
Vienna Maple



Honey Cherry

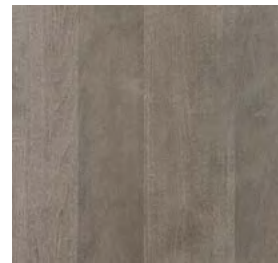

Glazed Driftwood

Winnebago® reserves the right to change décor materials and specifications without notice or obligation.

Choose from four collections and three wood finishes.

Infinity



Primera



Feature Fabric

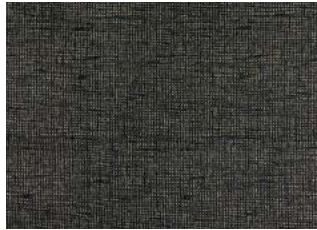

Bed Cover (22R, 25B)



Bedsread (NA 22R, 25B)



Laminate Countertop

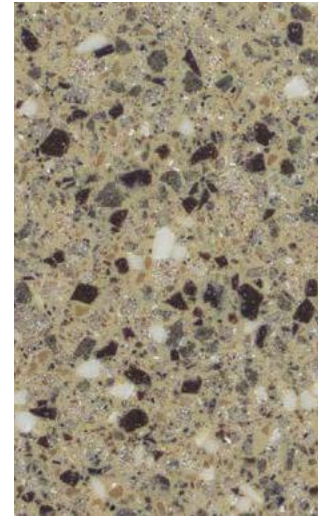

Corian Galley Countertop
(Premium Package Upgrade)



Vinyl Flooring

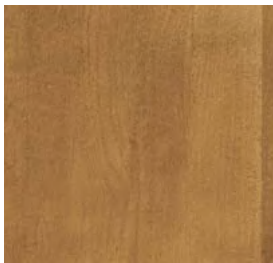

Coffee-Glazed
Vienna Maple



Honey Cherry

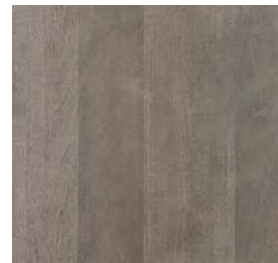

Glazed Driftwood

Winnebago® reserves the right to change décor materials and specifications without notice or obligation.

Choose from four collections and three wood finishes.

Rockslide



Primera



Feature Fabric



Bed Cover (22R, 25B)



Bedsread (NA 22R, 25B)



Laminate Countertop



Corian Galley Countertop
(Premium Package Upgrade)



Vinyl Flooring

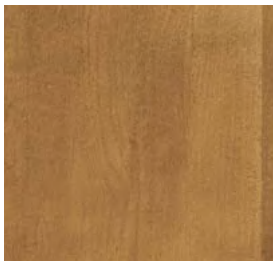

Coffee-Glazed
Vienna Maple



Honey Cherry

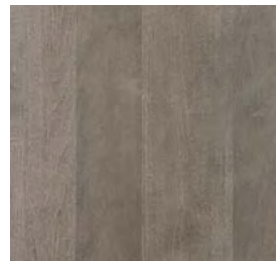

Glazed Driftwood

Winnebago® reserves the right to change décor materials and specifications without notice or obligation.

Choose from four collections and three wood finishes.

Stardust



Primera



Feature Fabric



Bed Cover (22R, 25B)



Bedsread (NA 22R, 25B)



Laminate Countertop

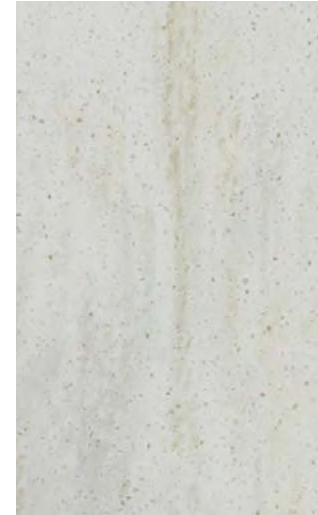

Corian Galley Countertop
(Premium Package Upgrade)



Vinyl Flooring

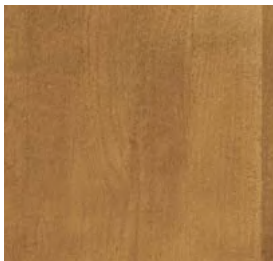

Coffee-Glazed
Vienna Maple



Honey Cherry

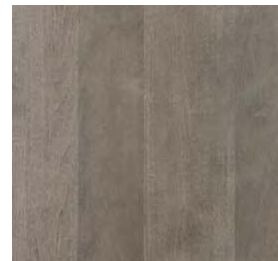

Glazed Driftwood

Winnebago® reserves the right to change décor materials and specifications without notice or obligation.

Choose from three stylish graphics selections with an available front cap upgrade.



Polar Tuscan Gold
STANDARD GRAPHICS

Available Front Cap

Choose from three stylish graphics selections with an available front cap upgrade.



Available Front Cap

Tuscan Gold
STANDARD GRAPHICS

Choose from three stylish graphics selections with an available front cap upgrade.



Available Front Cap

Bronze Mist
DELUXE GRAPHICS

 [Click here to explore this floorplan's web page.](#)

22R

This crafty floorplan packs a U-shaped dinette, large wardrobe, a rear corner bed, and a full galley into an easy-to-drive 24-footer.

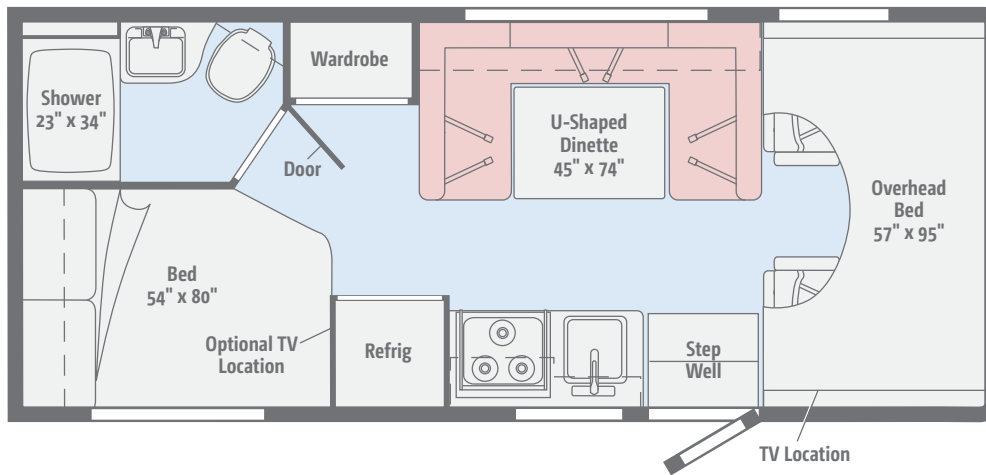

 [Click here to explore this floorplan's web page.](#)

25B

Four sleeping spaces, including a corner bed, a sofa/bed, overhead bed, and a dinette make this perfect for families or traveling couples.

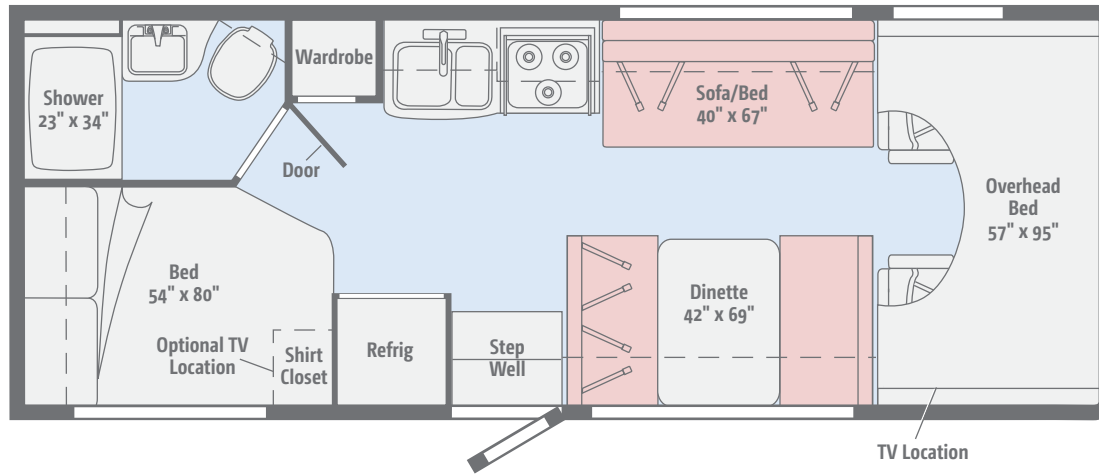

 [Click here to explore this floorplan's web page.](#)

NEW 26A

A multi-purpose U-shaped dinette with its own slideout makes optimal use of space, making this one of the most spacious 27-foot floorplans on the market.

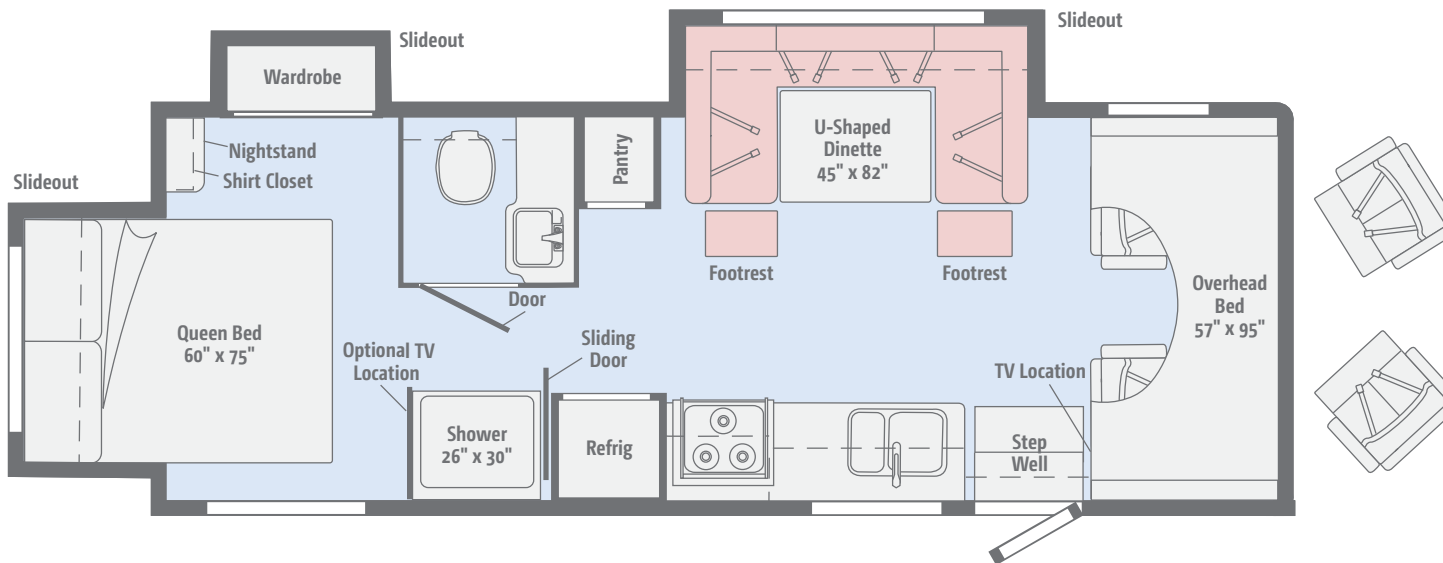

Click here to explore this floorplan's web page.

NEW 31D

Opposing lounge slideouts and a bedroom slide present a generous living space with room for a dinette, sofa/bed, and a large wardrobe.

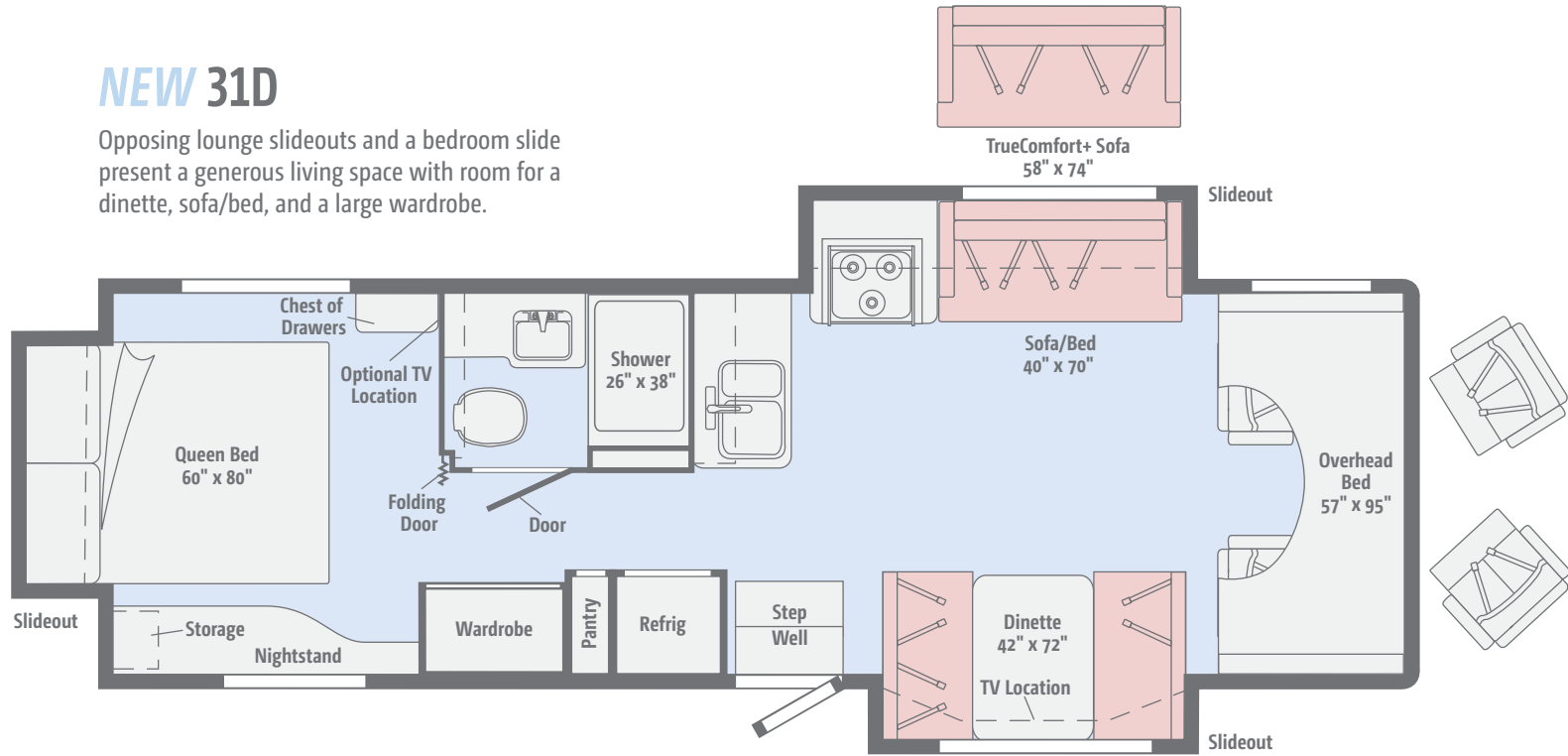

[Click here to explore this floorplan's web page.](#)

31G

The massive full-wall slideout expands every room in the coach and even reveals bunk beds that let you travel comfortably with a full house.

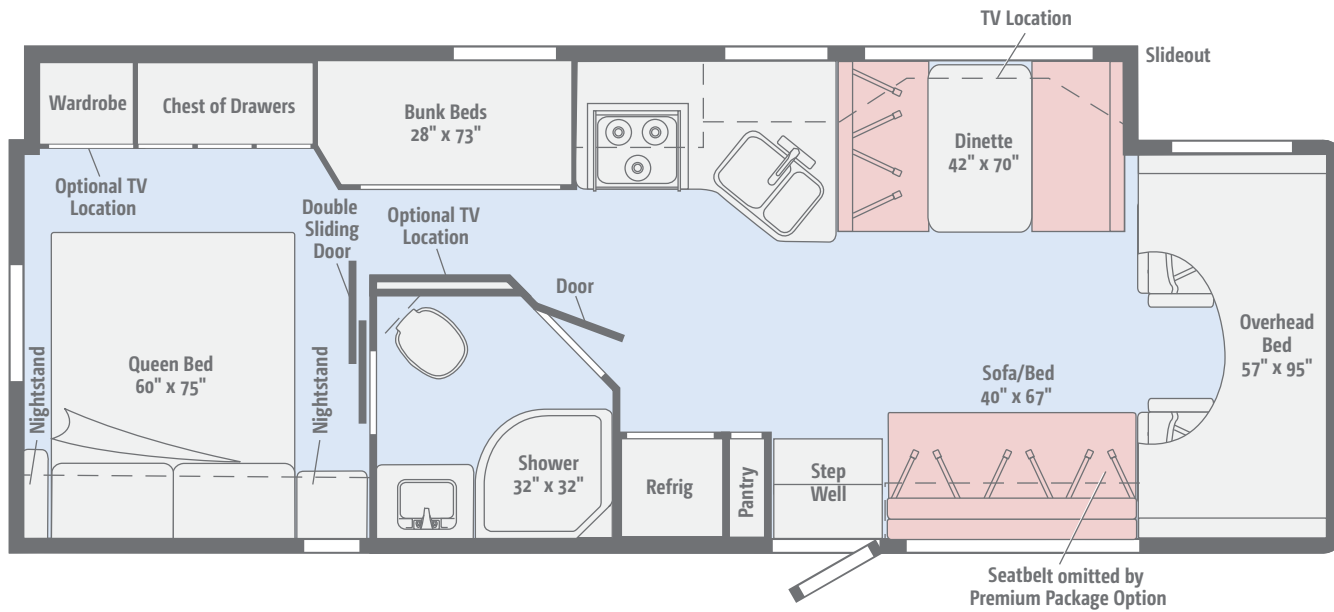

[Click here to explore this floorplan's web page.](#)

31K

A straight-line galley lends a more open feel to a living area featuring the U-shaped dinette and an available TrueComfort+ Sofa.

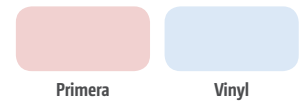
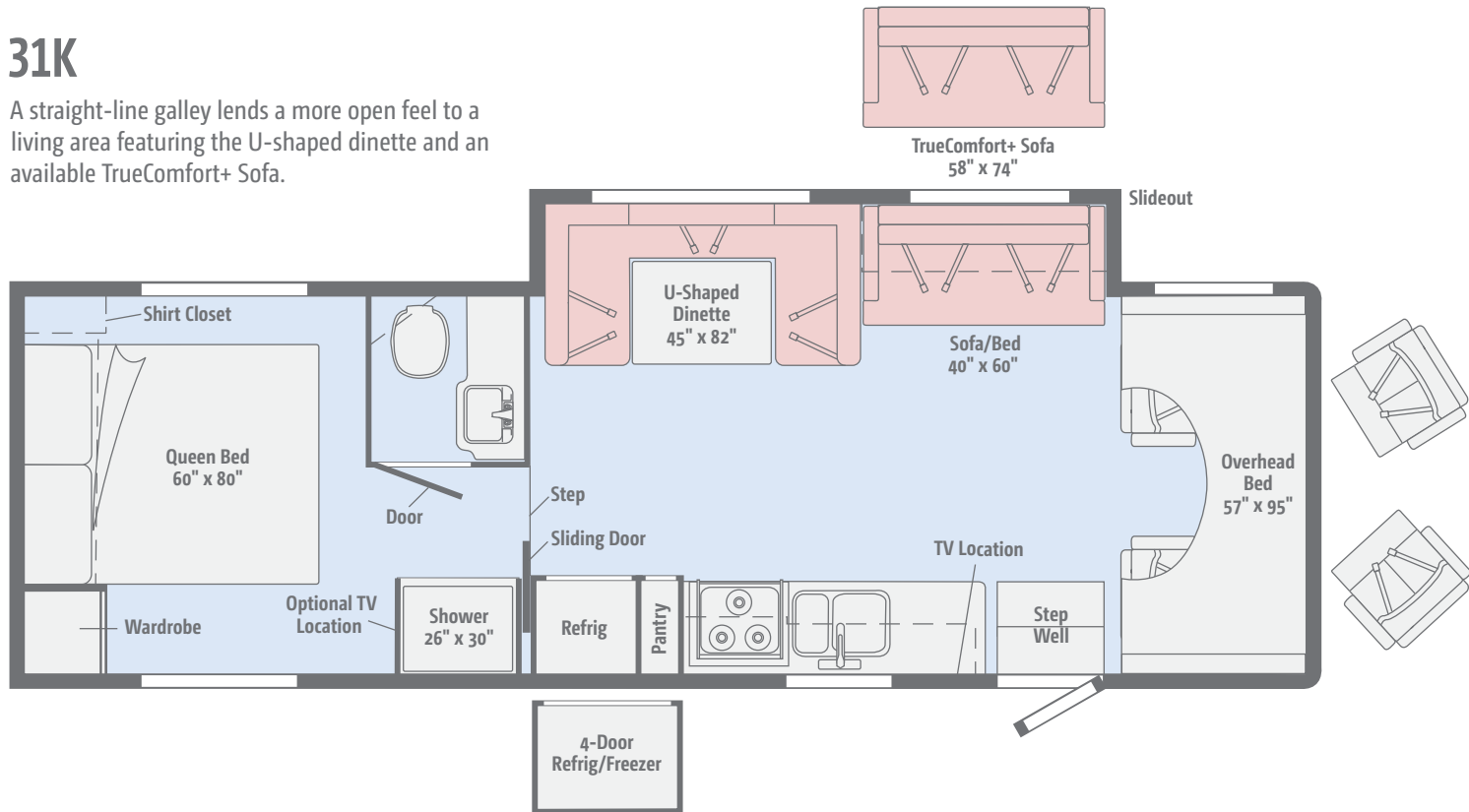

Weights & Measures	22R	25B	26A	31D	31G	31K
Length	23'10"	26'2"	27'1"	32'9"	32'9"	32'9"
Exterior Height ¹	11'	11'	11'1"	11'1"	11'1"	11'1"
Exterior Width ²	8'5.5"	8'5.5"	8'5.5"	8'5.5"	8'5.5"	8'5.5"
Exterior Storage ³ (cu. ft.)	61.1	76	45	92.9	86.1	101
Awning Length	14'	17'	18'	17'	19'	20'
Interior Height	6'10"	6'10"	6'10"/6'5.5"***	6'10"/6'5.5"***	6'10"/6'5.5"***	6'10"/6'5.5"***
Interior Width	8'	8'	8'	8'	8'	8'
Freshwater Tank Capacity ⁴ (gal.)	40	40	40	44	44	44
Water Heater Capacity (gal.)	6	6	6	6	6	6
Holding Tank Capacity - Black/Gray ⁴ (gal.)	21/24	23/27	35/32	37/30	37/57	30/30
LP Capacity ⁵ (gal.)	18	18	18	18	18	18
Fuel Capacity (gal.)	55	55	55	55	55	55
GCWR ⁶ (lbs.)	18,500 ^A /22,000 ^B	18,500 ^A /22,000 ^B	22,000 ^B	22,000 ^B	22,000 ^B	22,000 ^B
GVWR (lbs.)	11,500 ^A /14,500 ^B	11,500 ^A /14,500 ^B	14,500 ^B	14,500 ^B	14,500 ^B	14,500 ^B
GAWR - Front (lbs.)	4,600 ^A /5,000 ^B	4,600 ^A /5,000 ^B	5,000 ^B	5,000 ^B	5,000 ^B	5,000 ^B
GAWR - Rear (lbs.)	7,800 ^A /9,600 ^B	7,800 ^A /9,600 ^B	9,600 ^B	9,600 ^B	9,600 ^B	9,600 ^B
Wheelbase	158"	182"	190"	220"	220"	220"
Seating Capacity	5	6	6	6*/7	7	7

*Included with Premium Package **Rear of Coach ^AFord E350 Chassis ^BFord E450 Chassis

Optional Package Upgrades

Convenience Package front bunk ladder, bunk privacy curtain, additional deep-cycle, Group 24 battery, glass shower door, 3-burner range w/oven, rear ladder, Radio/Rearview Monitor System, stainless steel wheel liners and valve extenders, black tank flushing system, TrueLevel™ monitoring system

Premium Package (26A, 31D, 31G, 31K) Requires Convenience Package, Corian® countertop and backsplash, galley w/stainless steel undermount sink and Corian sink cover, recessed range w/oven and glass cover, Primera cab seat covers, 40" HDTV upgrade (31K), headboard upgrade (NA 26A), Dream Dinette™ table mechanism (31D, 31G), bedspread (NA 26A) w/pillow shams and fillers, power ventilator w/rain cover, electric lift, remote, exhaust airflow, DSI gas/electric water heater, dash appliqué, MCD solar/blackout roller shades (MCD blackout roller shades in bedroom), porcelain toilet w/sprayer, stainless steel bathroom sink, single-control faucets, window treatment upgrade, sofa pillows (NA 26A), frosted mirror refrigerator inserts, frosted mirror overhead door inserts, automatic generator change over switch

Exterior Tailgate Package (31G) 32" HDTV, stereo w/remote, AM/FM radio, DVD player w/remote, two exterior speakers, radio antenna, exterior wash station w/lighted pump switch, coiled water hose, quick-disconnect and sprayer head, refrigerator (2.6 cu. ft.), two shelves, LP QuickConnect, 110 V/AC receptacle, 24"x48" folding table

Chassis

Ford® E350 Chassis 305-hp 6.8L SEFI Triton V10 engine, TorqShift 6-speed automatic transmission w/overdrive, 155-amp. alternator

Ford E450 Chassis 305-hp 6.8L SEFI Triton V10 engine, TorqShift 6-speed automatic transmission w/overdrive, 155-amp. alternator

4-wheel ABS

Wheel covers

Rear auxiliary springs (31G)

Trailer hitch® 7,500-lb. drawbar/500-lb. maximum vertical tongue weight (NA 31D, 31G), 350-lb. maximum vertical tongue weight (31D, 31G)

OPTIONAL EQUIPMENT

Rear auxiliary springs (26A, 31D, 31K)

Hydraulic leveling jacks (front and rear) (31D, 31G, 31K)

Spare Tire (NA 25B w/E350 Chassis)

Cab Conveniences

Radio w/AM/FM stereo, CD player

Cab seats armrests, fixed lumbar support, and multi-adjustable slide/recline

3-point seat belts

Airbags driver and passenger

12-volt powerpoint

Power steering w/tilt and cruise control

Power door locks

Sunvisors

Manual mirrors w/pivoting arms

Cab mat

OPTIONAL EQUIPMENT

Swivel cab seat pedestal (26A, 31D, 31K) (driver and passenger)

Radio/Rearview Monitor System DVD receiver with 6.2" LCD color touch screen, handheld remote, iPod®/MP3 input, rear color camera, Bluetooth®, SiriusXM® (includes 90-day trial subscription), Spotify®, AppRadio One (included w/Convenience Package)

Mirrors w/defrost, remote and video camera (requires Convenience Package)

SiriusXM® satellite radio prep, receiver, antenna (subscription not included) (requires Convenience Package)

Interior

Amplified digital HDTV antenna

Pleated night shades (lounge, dinette, and bedroom)

Mini blinds (galley, bath)

Systems monitor panel

Roof vent (bedroom and front bunk area)

Blackout cab divider curtain (22R, 25B, 31G)

Front wraparound curtain (26A, 31D, 31K)

Tinted windows

Vinyl ceiling

USB charger (dinette and bedroom)

LED lighting

32" HDTV w/DVD player

Vinyl flooring throughout

Assist bar

OPTIONAL EQUIPMENT

Dual-glazed, thermo-insulated windows (NA 25B w/E350 Chassis)

Sofa sleeper (31D, 31K)

Galley

- Microwave oven** w/touch control
- 3-burner range top** w/storage below
- Vented range hood** w/light
- 2-door refrigerator/freezer**
- Decorative backsplash**
- Pantry** (NA 22R, 25B)

OPTIONAL EQUIPMENT

- 3-burner range** w/oven
- Microwave/convection oven** w/touch control (26A, 31D, 31K, 31G)
- 4-door refrigerator/freezer** w/icemaker (31K)

Bath

- Shower** 23"x34" (22R, 25B)
- Shower** 26"x30" (26A, 31K)
- Shower** 26"x38" (31D)
- Shower** 32"x32" (31G)
- Shower curtain** (NA 31G)
- Shower door** (31G)
- Flexible showerhead**
- Skylight**
- Towel ring(s)**
- Powered roof vent**
- Toilet** w/foot pedal
- Tissue holder**
- Robe hook(s)**
- Towel bar(s)** (31D, 31G)

Bedroom

- Double bed** w/2" foam mattress topper and mattress cover (22R, 25B)
- Queen bed** w/foam mattress and mattress cover (26A)
- Queen bed** w/foam mattress and bedspread (31D, 31G, 31K)
- Headboard** (NA 26A)
- Bunk beds** w/covered foam mattresses, mattress covers, storage compartment, and privacy curtains (31G)

OPTIONAL EQUIPMENT

- 24" HDTV**
- Bunk bed 24" HDTV** (31G)

Exterior

- Premium high-gloss fiberglass skin**
- Porch light** w/interior switch
- Running boards**
- Large lighted trunk storage compartment**
- Patio awning**

OPTIONAL EQUIPMENT

- Powered patio awning** w/LED lighting
- Molded front cap** (NA 25B w/E350 Chassis)

Heating & Cooling

- 20,000 BTU furnace** (22R, 25B)
- 30,000 BTU furnace** (26A, 31D, 31G, 31K)
- Coleman®-Mach® 15 A/C**

Electrical System

- AC/DC load center, 55-amp. converter/charger**
- 30-amp. power cord**
- TV jack and AC receptacle near entrance door**
- Deep-cycle, Group 24 battery**
- Coach battery disconnect system**
- Automatic dual-battery charge control**
- 4,000-watt Cummins Onan® Microquiet™ generator**
- Auxiliary start circuit**

OPTIONAL EQUIPMENT

- 2 deep-cycle batteries included** w/Convenience Package

Plumbing System

- Pressurized city water hookup** w/tank fill
- On-demand water pump**
- 6-gallon LP water heater** w/electronic ignition
- Permanent-mount LP tank** w/gauge

OPTIONAL EQUIPMENT

- Heated holding tanks**

Safety

- LP, smoke, and carbon monoxide detectors**
- 10 BC fire extinguisher**
- Ground fault interrupter**
- Child seat tether anchor**

Warranty⁷

- 12-month/15,000-mile basic limited warranty⁸**
- 36-month/36,000-mile limited warranty on structure⁸**
- 10-year limited parts-and-labor warranty on roof skin⁸**

FOOTNOTES

- The height of each model is measured to the top of the tallest standard feature and is based on the curb weight of a typically equipped unit. The actual height of your vehicle may vary by several inches depending on chassis or equipment variations. Please check with your dealer for further information.
- Floorplans feature a wide-body design - over 96" in making your purchase decision, you should be aware that some states restrict access on some or all state roads to 96" in body width. Before making your purchase decision, you should confirm the road usage laws in the states of interest to you.
- The load capacity of your motorhome is designated by weight, not by volume, so you cannot necessarily use all available space when loading your motorhome.
- Capacities are based on measurements prior to tank installation. Slight capacity variations can result due to installation applications.
- Capacities shown are tank manufacturer's listed water capacity (W.C.). Actual filled LP capacity is 80% of listing due to overfilling prevention device on tank.
- Actual towing capacity is dependent on your particular loading and towing circumstances which includes the GVWR, GAWR, and GCWR as well as adequate trailer brakes. Please refer to the Operator's Manual of your vehicle for further towing information.
- See separate chassis warranty.
- See your dealer for complete warranty information.

NA Not Available

Not all items available in combination. See dealer for details.

Winnebago's continuing program of product improvement makes specifications, equipment, model availability, and prices subject to change without notice. Published content reflects the most current product information at time of printing. Please consult your dealer for individual vehicle features and specifications.





Let us host your next

Adventure



WGOAdventures.com



WINNEBAGO

RV INSURANCE



From RV to personal insurance, Winnebago RV Insurance can provide all the coverage and services you need to feel at home on the road.

For more information:
(800) 642-4892

Connect with Winnebago (Click one of the following)



Like us



Follow us



Watch us

WinnebagoInd.com Has All The Answers

Visit WinnebagoInd.com on your computer, smartphone, or tablet for the latest product information and updates.

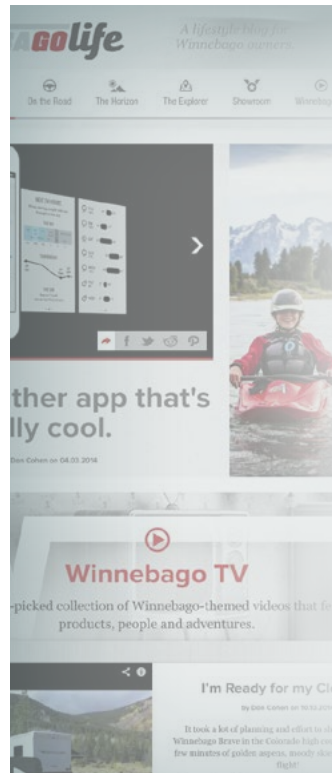

Welcome to GoLife!

Visit our lifestyle blog for motorhome news, personal travelogues, and community stories.

WinnebagoLife.com

GoLife

PREFERRED CARE PROGRAM

We back our motorhomes with best-in-class support both before and after the sale:

- 12-month/15,000-mile basic limited warranty
- 36-month/36,000-mile limited warranty on structure
- 10-year limited parts-and-labor warranty on fiberglass roof
- Complimentary 24-hour roadside assistance program
- TripSaver® Fast Track Parts guarantees that in-stock warranty parts ship directly to your dealer within 24 hours
- National dealer service network



For more information:
WGOService.com



WIT CLUB

Join the Club, Join the Fun

Here's the perfect way to begin your life on the road as the owner of a new Winnebago – by joining the exclusive WIT Club. Start your adventure with other fun-loving WIT Club members from across the country and get the most out of your new Winnebago motorhome.



Members enjoy:

- Caravans and rallies
- Newsletters
- Local and state group activities
- RV travel benefits

See more at
WITClub.com



Grand National Rally

Each year, thousands of Winnebago owners descend upon Forest City, Iowa. Rally-goers enjoy an unforgettable week reconnecting with friends, taking tours, participating in activities, and more. Join the adventure next July!

WINNEBAGO[®]

CONTACT US

GENERAL INQUIRIES

Corporate Switchboard
(641) 585-3535

CURRENT PRODUCT OWNER AND SERVICE-RELATED INQUIRIES

(800) 537-1885
or winnebagoind.com

NEW VEHICLE SALES INQUIRIES

sales@winnebagoind.com

FAX

(641) 585-6966

POSTAL ADDRESS

Winnebago Industries, Inc.
P.O. Box 152
Forest City, IA 50436

STREET ADDRESS

Winnebago Industries, Inc.
605 West Crystal Lake Road
Forest City, IA 50436

LA MESA RV

EXPERIENCE LIFE

www.lamesarv.com
800-496-8778